







Quality Marine Equipment
Since 1981

316L WORM DRIVE CLAMPS

- 
**7mm
SLOTTED HEX HEAD**
- 
**500°C MAX
OPERATING TEMP**
- 
**NON-PERFORATED
ROLLED EDGE**
- 
**CORROSION
RESISTANT 316L**



Lasts up to 2X longer in Corrosion Salt Spray tests than other leading brands!

Entirely 316L stainless steel with a non-perforated, rolled edge, embossed band with a one-piece riveting screw cage.

- Sizes available ½" - 7¼" (13mm - 180mm)
 - Embossed band and cage
 - Smooth inside band
 - Reliable
- Corrosion resistant 316L
 - One-piece riveting screw cage
 - Durable & stable clamping force

www.pyihoseclamp.com



Non-Perforated

Smooth Inside Band

Rolled Edges

LOWER IDLE TORQUE TEST*

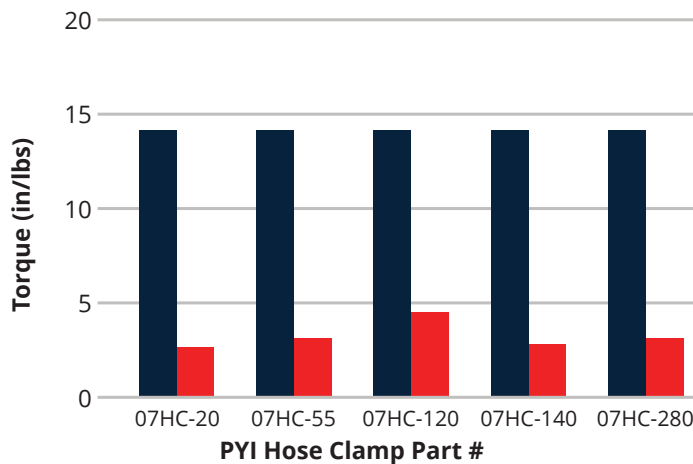

Industry Standard
 PYI Hose Clamp

DESTRUCTIVE-TURNING TORQUE TEST**

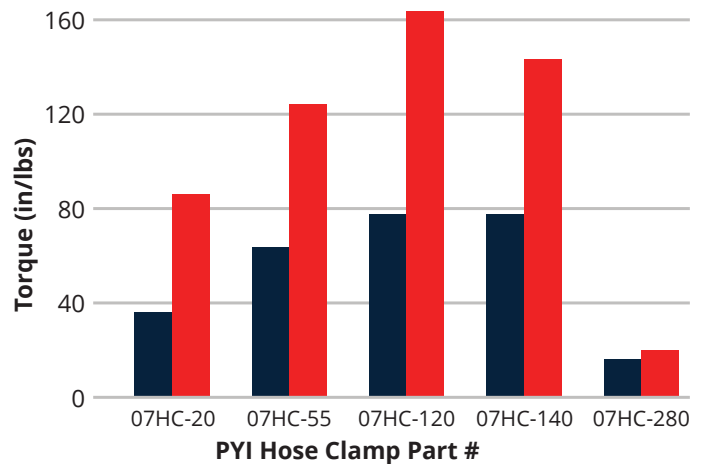

Industry Standard
 PYI Hose Clamp

* The Lower Idle Torque is the amount of torque required to twist the screw to tighten the clamp (lower is better).

** The Destructive Turning Torque Test measures how much force is required to break the hose clamp (higher is better).

RETAIL PRICE LIST

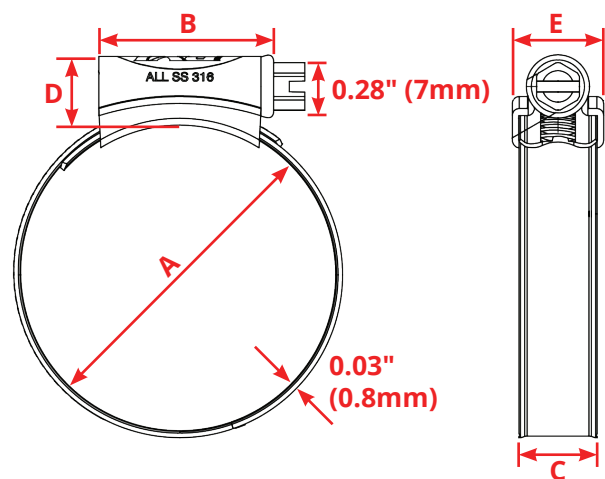

PART NUMBER (SINGLE QTY)	RETAIL PRICE (SINGLE QTY)	PART NUMBER (BULK 10 QTY)	PART NUMBER (BULK 5 QTY)	RETAIL PRICE (BULK QTY)	A	B	C	D	E	RECOMMENDED TORQUE
07-HC1-2	\$3.20	07-HC1-2B	—	\$30.00	0.37"-0.47" (9.5-12mm)	0.75" (19mm)	0.37" (9.5mm)	0.39" (10.0mm)	0.48" (12.3mm)	30 in/lbs
07-HC1-6	\$3.20	07-HC1-6B	—	\$31.00	0.43"-0.63" (11-16mm)	0.75" (19mm)	0.37" (9.5mm)	0.39" (10.0mm)	0.48" (12.3mm)	30 in/lbs
07-HC2-0	\$3.40	07-HC2-0B	—	\$33.00	0.50"-0.79" (13-20mm)	0.75" (19mm)	0.37" (9.5mm)	0.39" (10.0mm)	0.48" (12.3mm)	30 in/lbs
07-HC2-2	\$3.85	07-HC2-2B	—	\$37.00	0.63"-0.87" (16-22mm)	0.94" (24mm)	0.47" (12.0mm)	0.50" (12.5mm)	0.58" (14.65mm)	37 in/lbs
07-HC2-5	\$4.00	07-HC2-5B	—	\$38.00	0.71"-0.98" (18-25mm)	0.94" (24mm)	0.47" (12.0mm)	0.50" (12.5mm)	0.58" (14.65mm)	37 in/lbs
07-HC3-0	\$4.10	07-HC3-0B	—	\$39.00	0.87"-1.18" (22-30mm)	0.94" (24mm)	0.47" (12.0mm)	0.50" (12.5mm)	0.58" (14.65mm)	45 in/lbs
07-HC3-5	\$4.35	07-HC3-5B	—	\$41.00	0.98"-1.38" (25-35mm)	0.94" (24mm)	0.47" (12.0mm)	0.50" (12.5mm)	0.58" (14.65mm)	45 in/lbs
07-HC4-0	\$4.40	07-HC4-0B	—	\$42.00	1.18"-1.57" (30-40mm)	0.94" (24mm)	0.47" (12.0mm)	0.50" (12.5mm)	0.58" (14.65mm)	45 in/lbs
07-HC4-5	\$4.50	07-HC4-5B	—	\$44.00	1.38"-1.78" (35-45mm)	0.94" (24mm)	0.47" (12.0mm)	0.50" (12.5mm)	0.58" (14.65mm)	45 in/lbs
07-HC5-0	\$4.60	07-HC5-0B	—	\$45.00	1.38"-1.97" (35-50mm)	1.30" (33mm)	0.47" (12.0mm)	0.50" (12.5mm)	0.58" (14.65mm)	52 in/lbs
07-HC5-5	\$4.60	07-HC5-5B	—	\$46.00	1.57"-2.16" (40-55mm)	1.30" (33mm)	0.47" (12.0mm)	0.50" (12.5mm)	0.58" (14.65mm)	52 in/lbs
07-HC6-0	\$5.00	07-HC6-0B	—	\$48.00	1.78"-2.36" (45-60mm)	1.30" (33mm)	0.47" (12.0mm)	0.50" (12.5mm)	0.58" (14.65mm)	52 in/lbs
07-HC7-0	\$5.35	07-HC7-0B	—	\$51.00	2.17"-2.76" (55-70mm)	1.30" (33mm)	0.47" (12.0mm)	0.50" (12.5mm)	0.58" (14.65mm)	60 in/lbs
07-HC8-0	\$5.80	07-HC8-0B	—	\$56.00	2.36"-3.15" (60-80mm)	1.30" (33mm)	0.47" (12.0mm)	0.50" (12.5mm)	0.58" (14.65mm)	60 in/lbs
07-HC9-0	\$5.85	07-HC9-0B	—	\$58.00	2.76"-3.54" (70-90mm)	1.30" (33mm)	0.47" (12.0mm)	0.50" (12.5mm)	0.58" (14.65mm)	60 in/lbs
07-HC1-00	\$6.25	07-HC1-00B	—	\$60.00	3.35"-3.94" (85-100mm)	1.30" (33mm)	0.47" (12.0mm)	0.50" (12.5mm)	0.58" (14.65mm)	60 in/lbs
07-HC1-20	\$7.50	07-HC1-20B	—	\$72.00	3.54"-4.72" (90-120mm)	1.30" (33mm)	0.47" (12.0mm)	0.50" (12.5mm)	0.58" (14.65mm)	60 in/lbs
07-HC1-25	\$8.00	07-HC1-25B	—	\$76.00	3.94"-4.92" (100-125mm)	1.30" (33mm)	0.47" (12.0mm)	0.50" (12.5mm)	0.58" (14.65mm)	60 in/lbs
07-HC1-40	\$8.35	07-HC1-40B	—	\$80.00	4.72"-5.51" (120-140mm)	1.30" (33mm)	0.47" (12.0mm)	0.50" (12.5mm)	0.58" (14.65mm)	60 in/lbs
07-HC1-50	\$8.35	07-HC1-50B	—	\$82.00	5.11"-5.91" (130-150mm)	1.30" (33mm)	0.47" (12.0mm)	0.50" (12.5mm)	0.58" (14.65mm)	60 in/lbs
07-HC1-60	\$8.80	—	07-HC1-60B	\$43.00	5.12"-6.30" (130-160mm)	1.30" (33mm)	0.47" (12.0mm)	0.50" (12.5mm)	0.58" (14.65mm)	52 in/lbs
07-HC1-80	\$9.85	—	07-HC1-80B	\$48.00	5.91"-7.10" (150-180mm)	1.30" (33mm)	0.47" (12.0mm)	0.50" (12.5mm)	0.58" (14.65mm)	52 in/lbs
07-HC2-00	\$10.60	—	07-HC2-00B	\$52.00	6.70"-7.87" (170-200mm)	1.30" (33mm)	0.47" (12.0mm)	0.50" (12.5mm)	0.58" (14.65mm)	52 in/lbs
07-HC2-30	\$10.65	—	07-HC2-30B	\$53.00	7.48"-9.05" (190-230mm)	1.30" (33mm)	0.47" (12.0mm)	0.50" (12.5mm)	0.58" (14.65mm)	52 in/lbs
07-HC2-50	\$11.30	—	07-HC2-50B	\$55.00	8.66"-9.84" (220-250mm)	1.30" (33mm)	0.47" (12.0mm)	0.50" (12.5mm)	0.58" (14.65mm)	52 in/lbs
07-HC2-80	\$11.95	—	07-HC2-80B	\$58.00	9.45"-11.02" (240-280mm)	1.30" (33mm)	0.47" (12.0mm)	0.50" (12.5mm)	0.58" (14.65mm)	52 in/lbs
07-HC3-00	\$12.25	—	07-HC3-00B	\$60.00	10.63"-11.80" (270-300mm)	1.30" (33mm)	0.47" (12.0mm)	0.50" (12.5mm)	0.58" (14.65mm)	52 in/lbs
07-HC3-30	\$13.05	—	07-HC3-30B	\$64.00	11.42"-13" (290-330mm)	1.30" (33mm)	0.47" (12.0mm)	0.50" (12.5mm)	0.58" (14.65mm)	52 in/lbs
07-HC3-60	\$13.45	—	07-HC3-60B	\$66.00	12.60"-14.17" (320-360mm)	1.30" (33mm)	0.47" (12.0mm)	0.50" (12.5mm)	0.58" (14.65mm)	52 in/lbs
07-HC3-80	\$14.00	—	07-HC3-80B	\$68.00	13.78"-14.96" (350-380mm)	1.30" (33mm)	0.47" (12.0mm)	0.50" (12.5mm)	0.58" (14.65mm)	52 in/lbs

PRODUCT CROSS REFERENCE GUIDE

PYI HOSE CLAMP PART #	RANGE OF ADJUSTMENT	SAE	BRANDS			
			ABA	AWAB	MURRAY	TRIDON
07HC-12	0.37"-0.47" (9.5-12mm)	-	-	-	EBL12x012SS	-
07HC-16	0.43"-0.63" (11-16mm)	4	-	316017	EBL12x016SS	-
07HC-20	0.50"-0.79" (13-20mm)	8	0813 4003 020	316020	EBL12x022SS	-
07HC-22	0.63"-0.87" (16-22mm)	8	0813 4003 020	316024	EBL12x022SS	53415-0027
07HC-25	0.71"-0.98" (18-25mm)	10	0813 4003 024	316028	EBL12x027SS	53415-0027
07HC-30	0.87"-1.18" (22-30mm)	12	0813 4003 027	316032	EBL12x032SS	53415-0032
07HC-35	0.98"-1.38" (25-35mm)	16	0813 4003 032	316038	EBL12x040SS	53415-0040
07HC-40	1.18"-1.57" (30-40mm)	20	0813 4003 038	316044	EBL12x045SS	53415-0045
07HC-45	1.38"-1.78" (35-45mm)	20, 22	0813 4003 038	316044	EBL12x050SS	53415-0045
07HC-50	1.38"-1.97" (35-50mm)	24	0813 4003 044	316050	EBL12x050SS	53415-0050
07HC-55	1.57"-2.16" (40-55mm)	24, 28	0813 4003 050	316057	EBL12x060SS	53415-0060
07HC-60	1.78"-2.36" (45-60mm)	28, 32	0813 4003 050	316064	EBL12x060SS	53415-0060
07HC-70	2.17"-2.76" (55-70mm)	34, 36	0813 4003 067	316070	EBL12x070SS	53415-0075
07HC-80	2.36"-3.15" (60-80mm)	40, 44	0813 4003 077	316083	EBL12x080SS	53415-0080
07HC-90	2.76"-3.54" (70-90mm)	48	0813 4003 077	316095	EBL12x090SS	53415-0090
07HC-100	3.35"-3.94" (85-100mm)	52, 56	0813 4003 100	316102	EBL12x100SS	53415-0100
07HC-120	3.54"-4.72" (90-120mm)	60, 64	0813 4003 100	316127	EBL12x110SS	53415-0110
07HC-125	3.94"-4.92" (100-125mm)	64, 80	0813 4003 121	316127	EBL12x120SS	53415-0120
07HC-140	4.72"-5.51" (120-140mm)	72, 80	0813 4003 121	316140	EBL12x140SS	53415-0140
07HC-150	5.11"-5.91" (130-150mm)	88	0813 4003 148	316152	EBL12x150SS	53415-0150
07HC-160	5.12"-6.30" (130-160mm)	96	0813 4003 148	316165	EBL12x160SS	53415-0160
07HC-180	5.91"-7.10" (150-180mm)	104	0813 4003 165	316178	-	-
07HC-200	6.70"-7.87" (170-200mm)	104, 122	0813 4003 190	316203	-	-
07HC-230	7.48"-9.05" (190-230mm)	122, 138	0813 4003 216	316232	-	-
07HC-250	8.66"-9.84" (220-250mm)	138, 154	0813 4003 241	316257	-	-
07HC-280	9.45"-11.02" (240-280mm)	154, 170	0813 4003 267	316283	-	-
07HC-300	10.63"-11.80" (270-300mm)	170, 186	0813 4003 292	316308	-	-
07HC-330	11.42"-13" (290-330mm)	200	-	-	-	-
07HC-360	12.60"-14.17" (320-360mm)	224	-	-	-	-
07HC-380	13.78"-14.96" (350-380mm)	232	-	-	-	-

* Actual size ranges may vary

FLEXIBLE HOSE CLAMP DRIVER

PART NUMBER: 07-HCT
RETAIL PRICE: \$10.50

The flexible shaft allows for access in tight spaces such as plumbing repair, automotive, marine engines, etc. The socket fits all PYI Hose Clamps or any hose clamp with 7mm screw heads.



PYI Inc.
 12532 Beverly Park Road
 Lynnwood, WA 98087
 425-355-3669
 info@pyiinc.com
 www.pyiinc.com

CLAMP JACKETS

The unique sleeve design allows the Clamp Jacket to slip over the tail of a hose clamp to provide a worker protection from cuts and abrasion from exposed clamp tails.



PART NUMBERS

QTY	5/16"	1/2"	1/4"
25	CJ516-25 (\$6.00)	CJ-12-25 (\$6.00)	CJ-T14-25 (\$8.00)
100	CJ-516-100 (\$21.00)	CJ-12-100 (\$21.00)	CJ-T14-100 (\$28.00)

Bulk quantities available.

Get social with us!

